

FB3001 fence-on-a-step-bench display

ASSEMBLY INSTRUCTIONS

IMPORTANT

Please read these instructions carefully before beginning to assemble this display. Save instructions for future reference.



US PATENT #5,553,551

P.O. Box 458
27725 Danville Avenue
Castle Rock, MN 55010
www.poly-tex.com

U.S. & Canada Toll Free
800-852-3443
(651) 463-7009
fax (651) 463-2479

POLY-TEX
Greenhouse & Display Systems

PARTS IDENTIFICATION

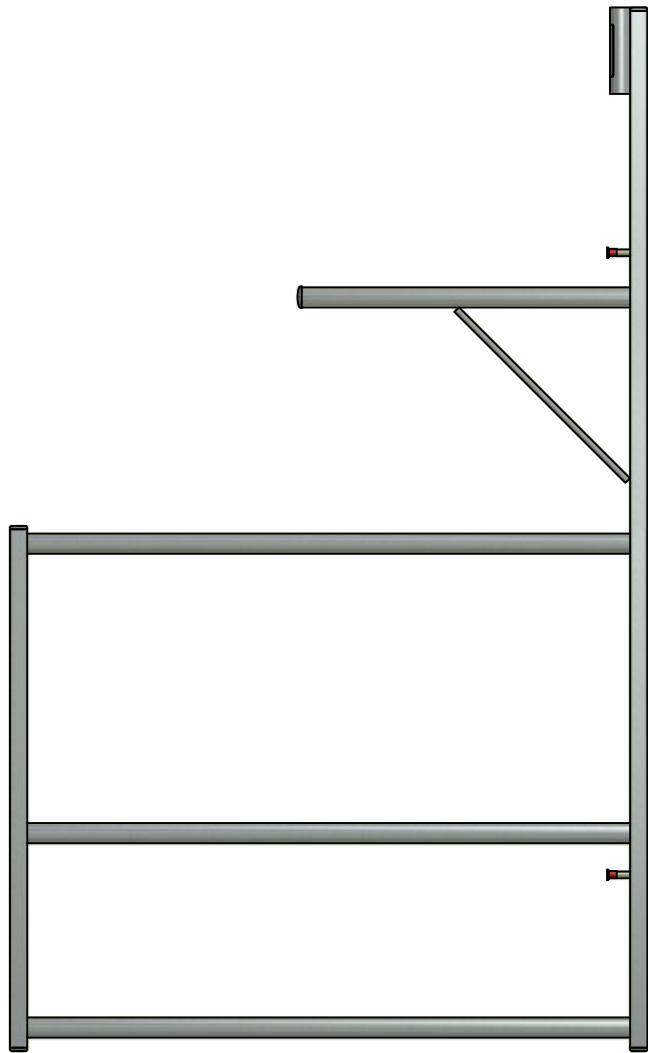

FB2805
BENCH END
(2)

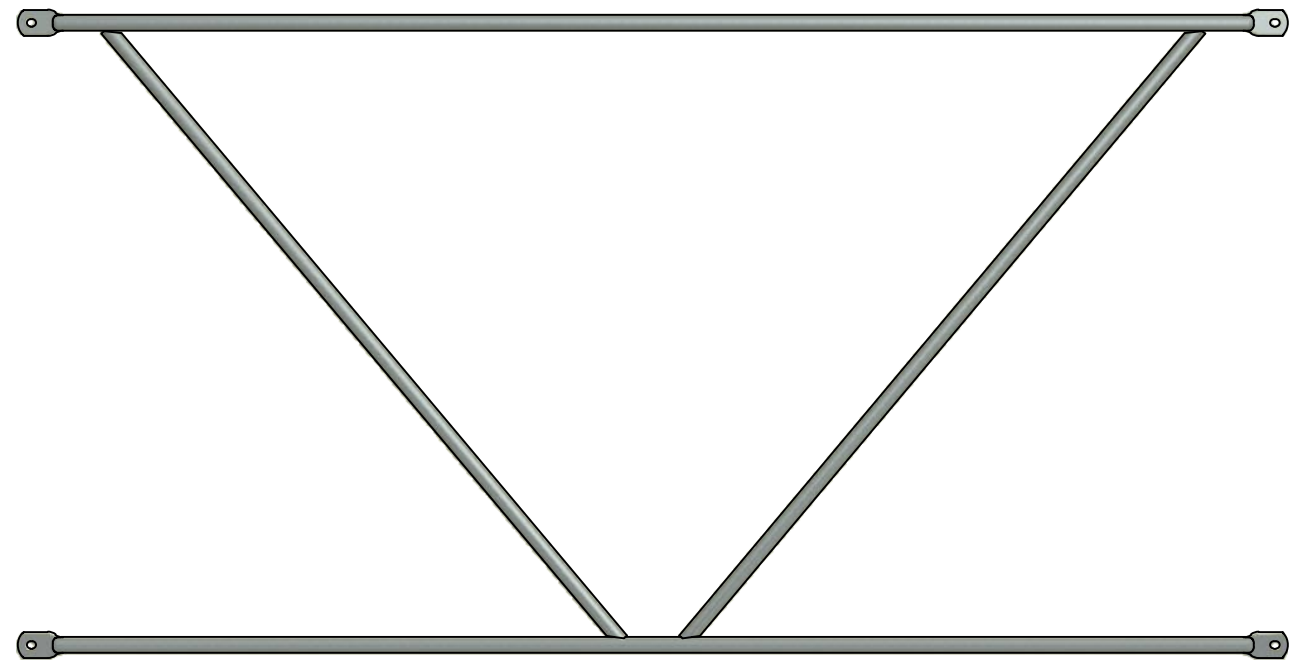

FB2533
36" STABILIZER
(1)



RF2552
3' x 6' R.F. BENCH TOP
(2)



RF2554
1'6" x 6' R.F. BENCH TOP
(1)

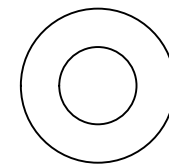

NB1923
NYLON WASHER
(4)



NB1901
3/8" WING NUT
(4)



NB1924
THUMB SCREW
(6)

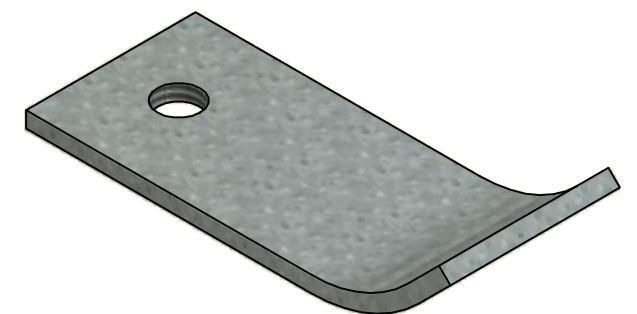

FT3600
NORSTAD CLIP
(6)

TOOLS & EQUIPMENT REQUIRED

No tools are required for the assembly of this product.

ASSEMBLY INSTRUCTIONS

3/8" WING NUT
NYLON WASHER

36" STABILIZER

BENCH END

ATTACH 36" STABILIZER TO BENCH ENDS AND FASTEN WITH WING NUTS & NYLON WASHERS.

PLACE BENCH TOPS IN POSITION.

INSTALL NORSTAD CLIPS IN THE MIDDLE OF EACH BENCH END.

BENCH TOP

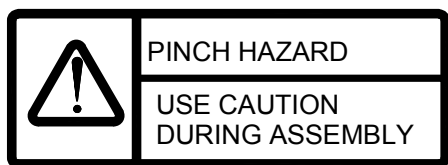

PINCH HAZARD
USE CAUTION
DURING ASSEMBLY

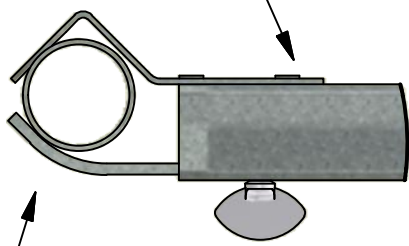

NORSTAD CLIP

THUMB SCREW

1'-6" X 6' BENCH TOP

3' X 6' BENCH TOP

3' X 6' BENCH TOP

OPTIONAL BASKET PURLIN



PARTS IDENTIFICATION



GM4000
6'-1 1/2" BASKET PURLIN
(1)



FB2007
BASKET PURLIN SUPPORT
(2)



NB1831
5/16" x 1"
CARRIAGE BOLT
(2)



NB1903
5/16" WING NUT
(2)



NB1862
5/16" LOCK WASHER
(2)

OPTIONAL BASKET PURLIN ASSEMBLY INSTRUCTION

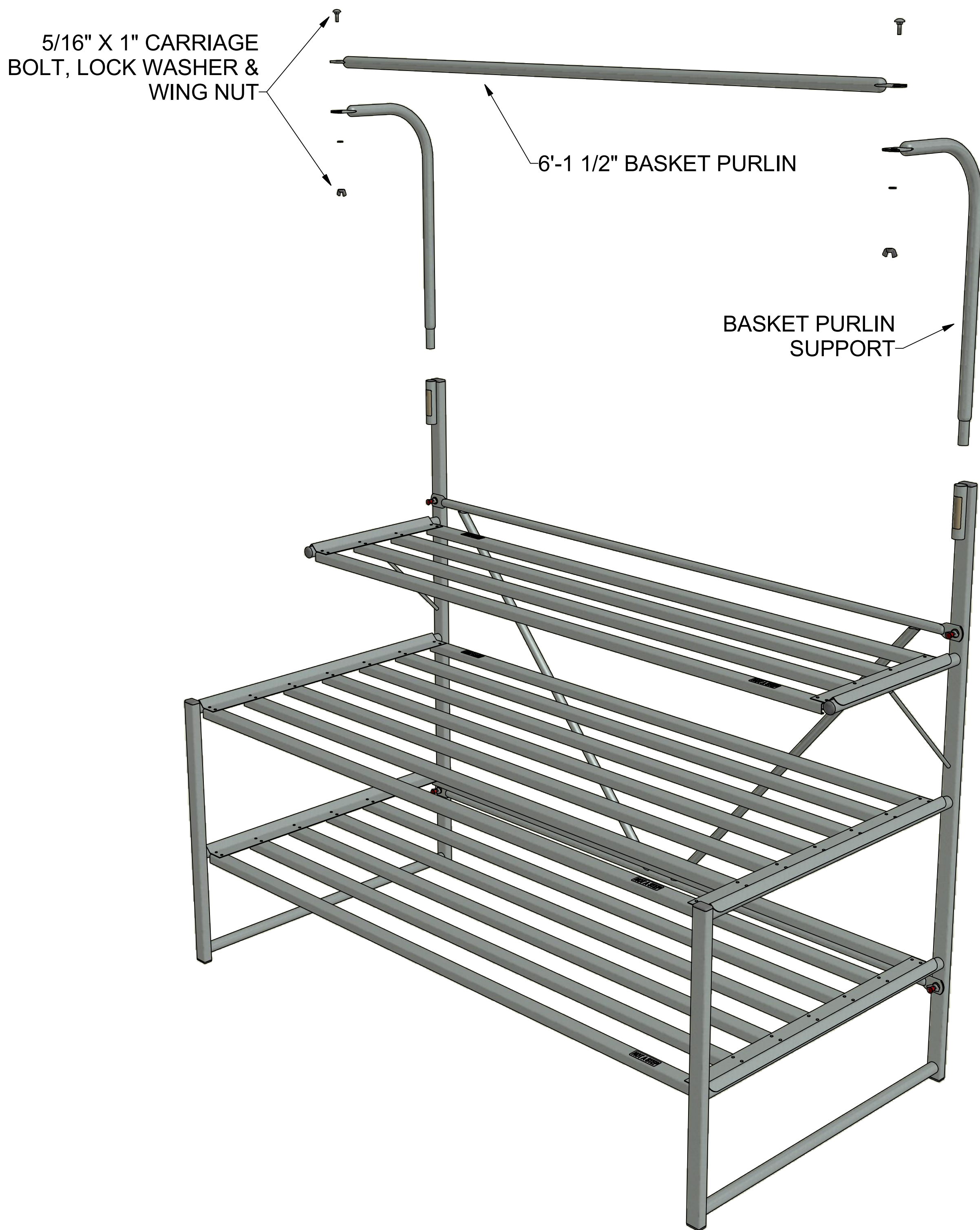

INSTRUCTIONS:

1. INSERT BASKET PURLIN SUPPORTS INTO SOCKETS.
2. ATTACH BASKET PURLIN USING 5/16" X 1" CARRIAGE BOLTS, LOCK WASHERS, & WING NUTS.

OPTIONAL BASKET TOWER



PARTS IDENTIFICATION

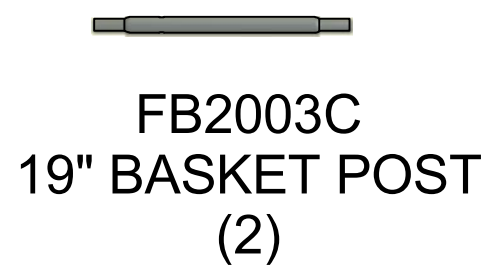
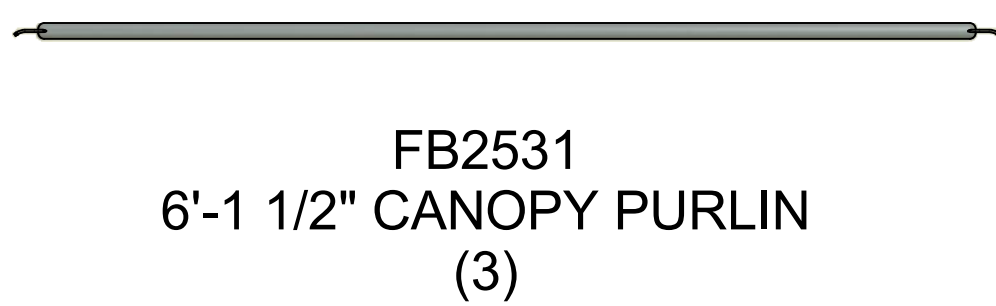
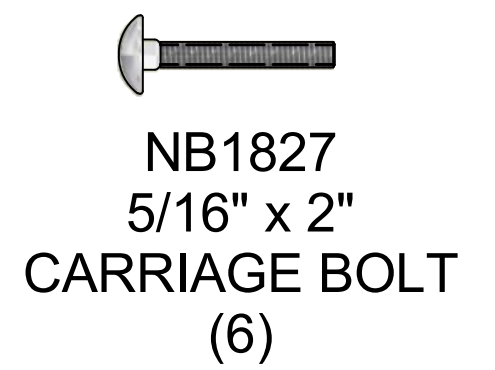
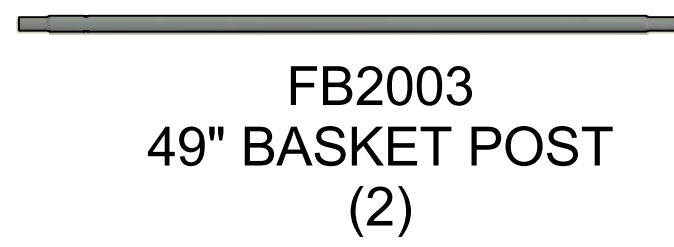
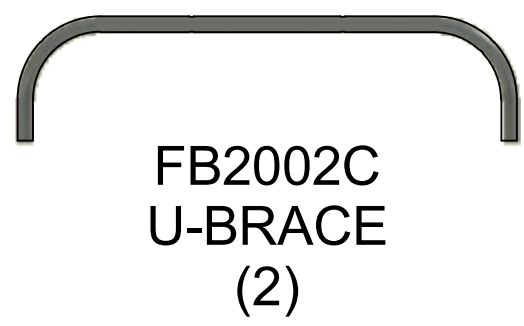
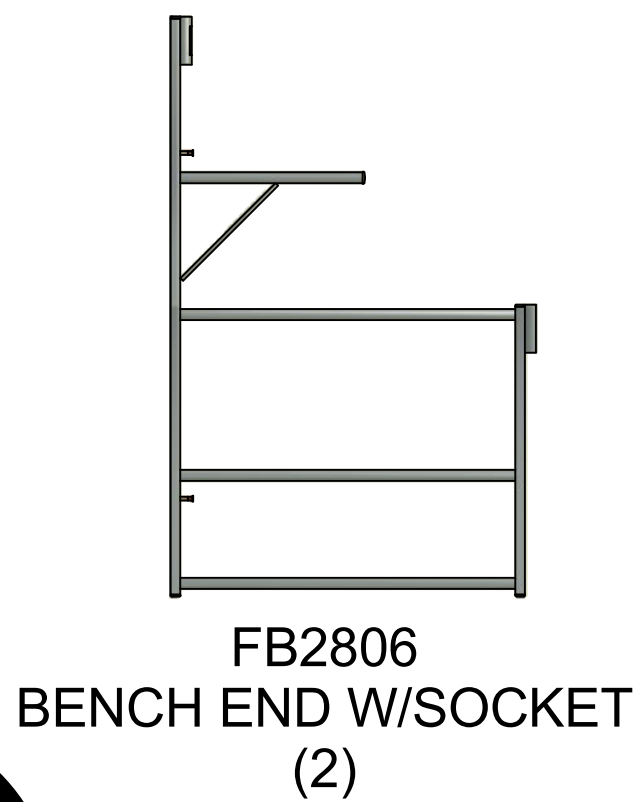

OPTIONAL BASKET TOWER ASSEMBLY INSTRUCTION



INSTRUCTIONS:

1. INSERT 49" BASKET POSTS INTO SOCKETS ON LOWER BENCHING & INSERT 19" BASKET POSTS INTO UPPER SOCKETS.
2. ATTACH U-BRACES TO 49" & 19" BASKET POST.
3. ATTACH CANOPY PURLINS TO U-BRACES AND BASKET POSTS USING 2" LONG CARRIAGE BOLT, LOCK WASHER AND WING NUT.

OPTIONAL BASKET TOWER CANOPY



PARTS IDENTIFICATION



FB2531
6'-1 1/2" CANOPY PURLIN
(3)

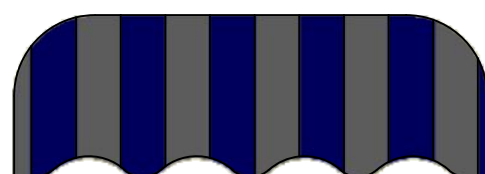
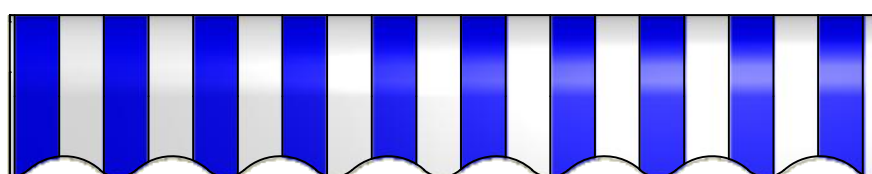

CANOPY
(1)

NB1827 - 6
NB1862 - 6
NB1903 - 6

OPTIONAL BASKET TOWER CANOPY ASSEMBLY



INSTRUCTIONS:

1. ATTACH CANOPY PURLINS TO U-BRACES USING 2" LONG CARRIAGE BOLTS, LOCK WASHERS, AND WING NUTS.
2. PLACE CANOPY OVER TOP OF CANOPY TOWER AND SECURE WITH VELCRO STRAPS.

OPTIONAL A-TOWER



OPTIONAL A-TOWER PARTS IDENTIFICATION

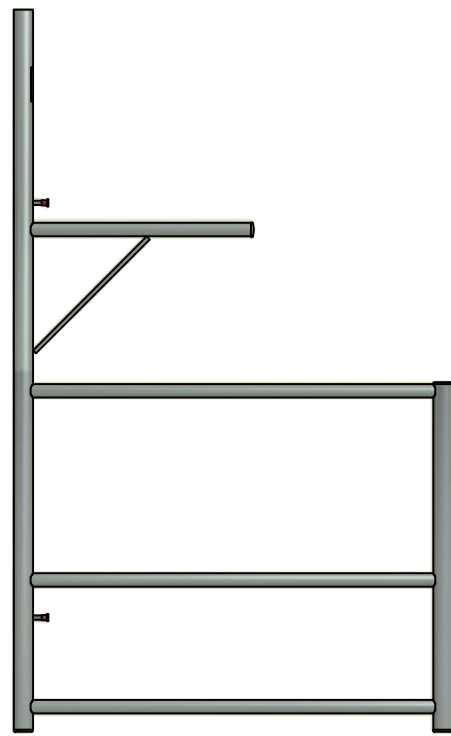

NB1827 - 6
NB1862 - 6
NB1903 - 6

FB2807
BENCH END (1.66)
(2)



FB2531
6'-1 1/2" CANOPY PURLIN
(3)



FB2530
CANOPY BRACE
(2)

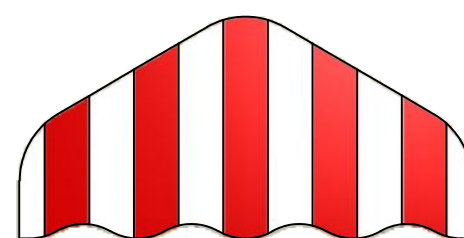
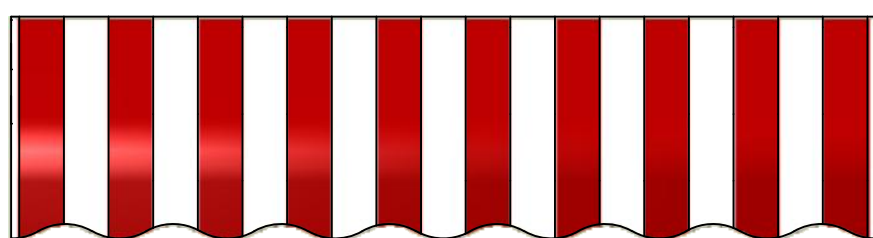

CANOPY
(1)

OPTIONAL A-TOWER & CANOPY ASSEMBLY

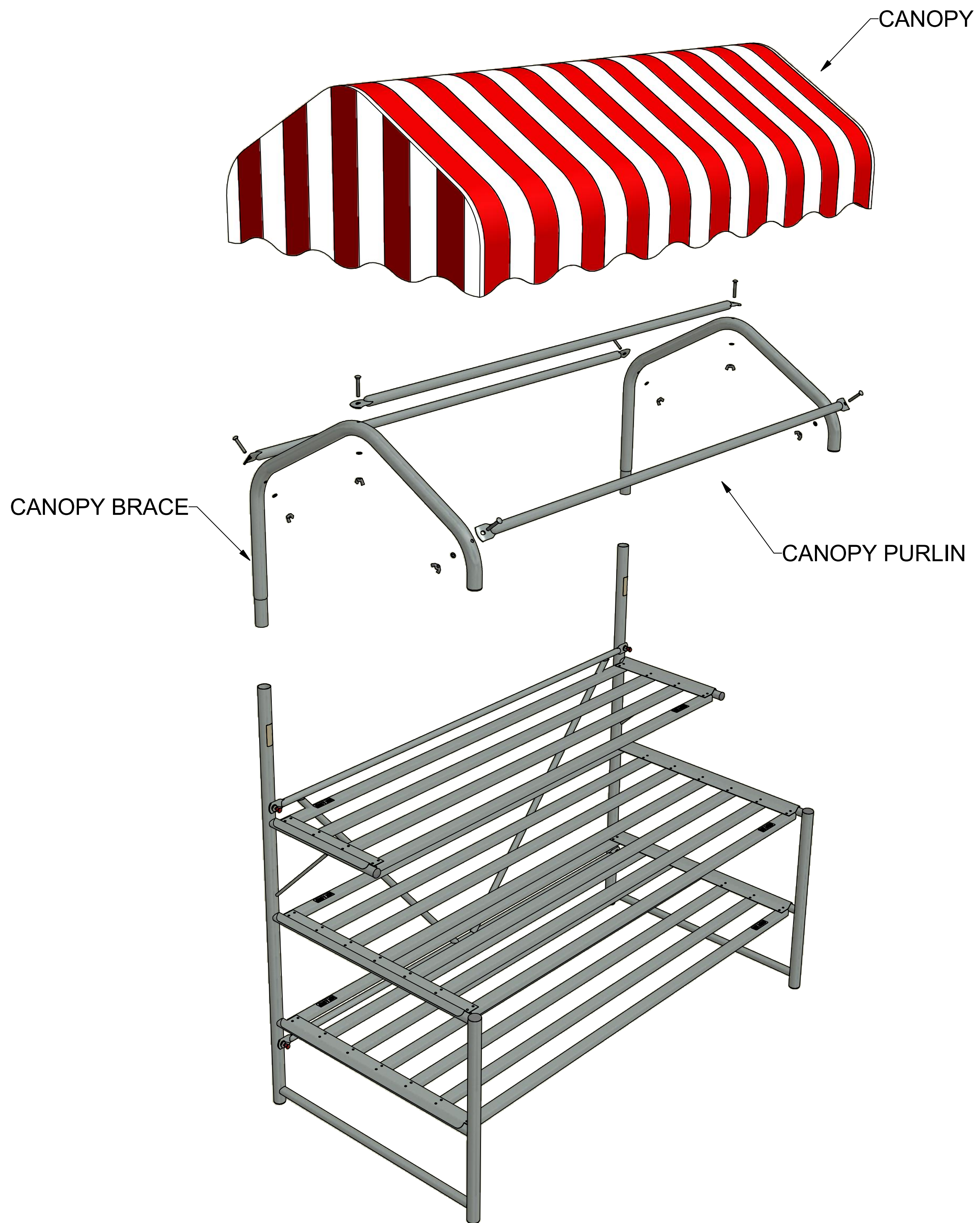

INSTRUCTIONS:

1. PLACE CANOPY BRACES INTO BENCH ENDS.
2. ATTACH CANOPY PURLINS TO CANOPY BRACES WITH 5/16" x 2-1/4" LONG CARRIAGE BOLTS, LOCK WASHERS, AND WING NUTS.
3. PLACE CANOPY OVER TOWER AND SECURE WITH VELCRO STRAPS.

OPTIONAL CASTER ASSEMBLY INSTRUCTIONS

INSTRUCTIONS:

1. REMOVE BOTTOM PLUGS.
2. INSTALL CASTER RAIL.
3. FASTEN WITH THUMB SCREWS. BE SURE CASTER STUB IS INSTALLED AS SHOWN IN ILLUSTRATION.

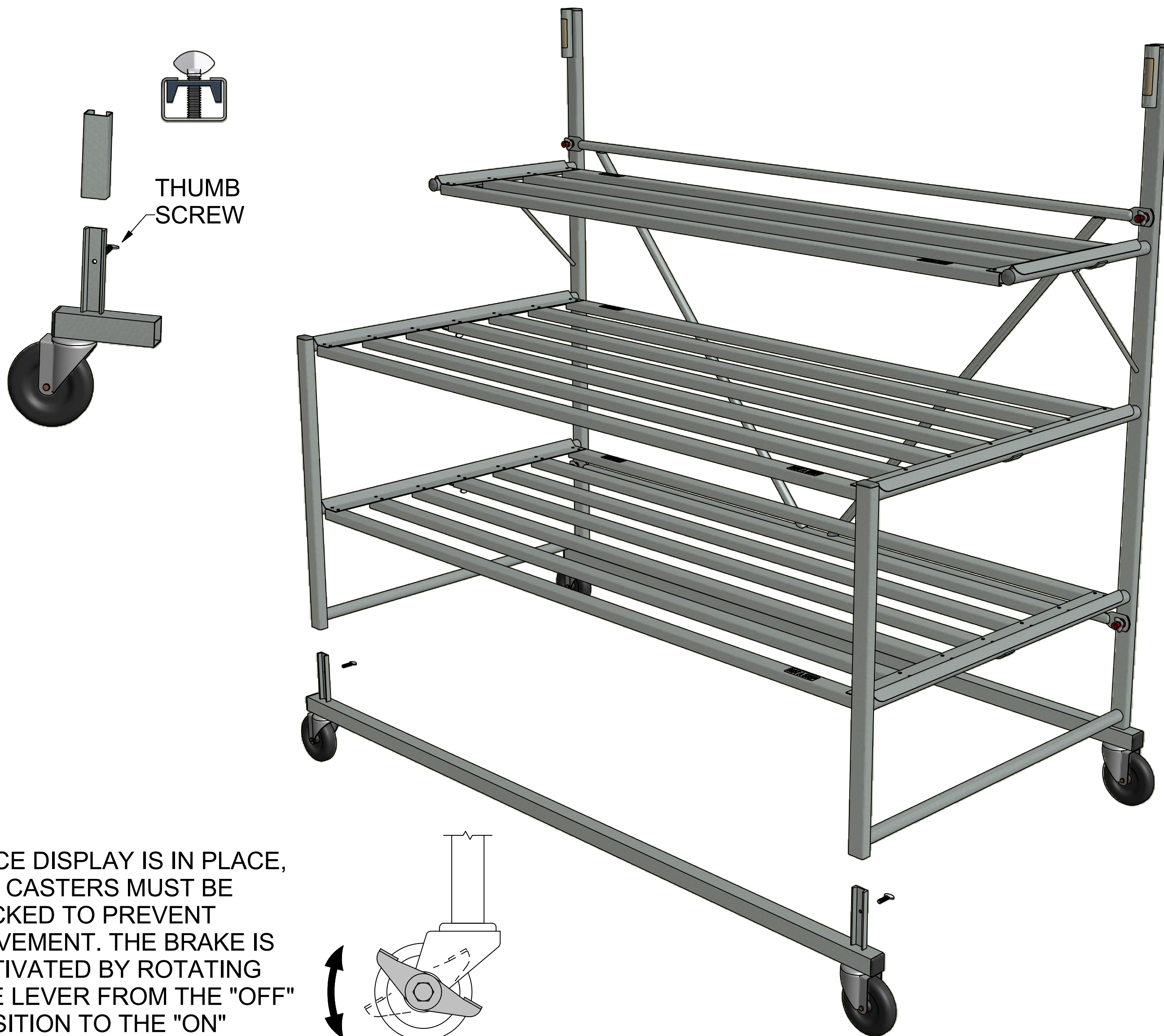

ONCE DISPLAY IS IN PLACE, ALL CASTERS MUST BE LOCKED TO PREVENT MOVEMENT. THE BRAKE IS ACTIVATED BY ROTATING THE LEVER FROM THE "OFF" POSITION TO THE "ON" POSITION.

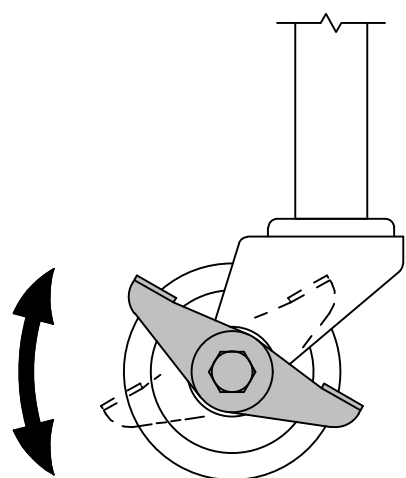

PARTS IDENTIFICATION

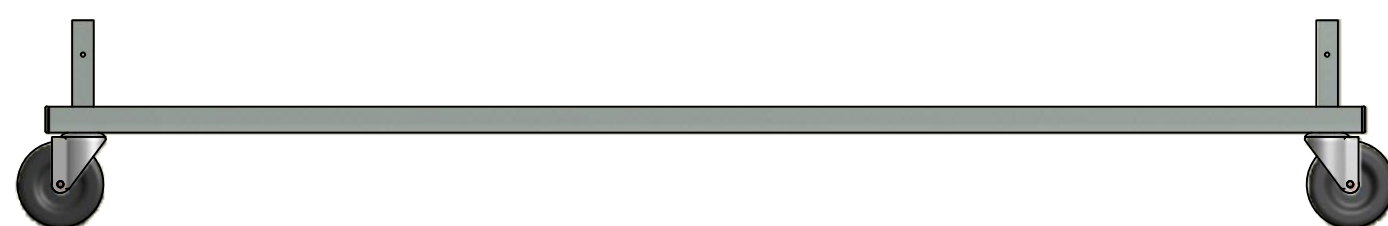

FB2004
SWIVEL/LOCK CASTER
(2)

ASSEMBLY INSTRUCTIONS - CONNECTED RUNS

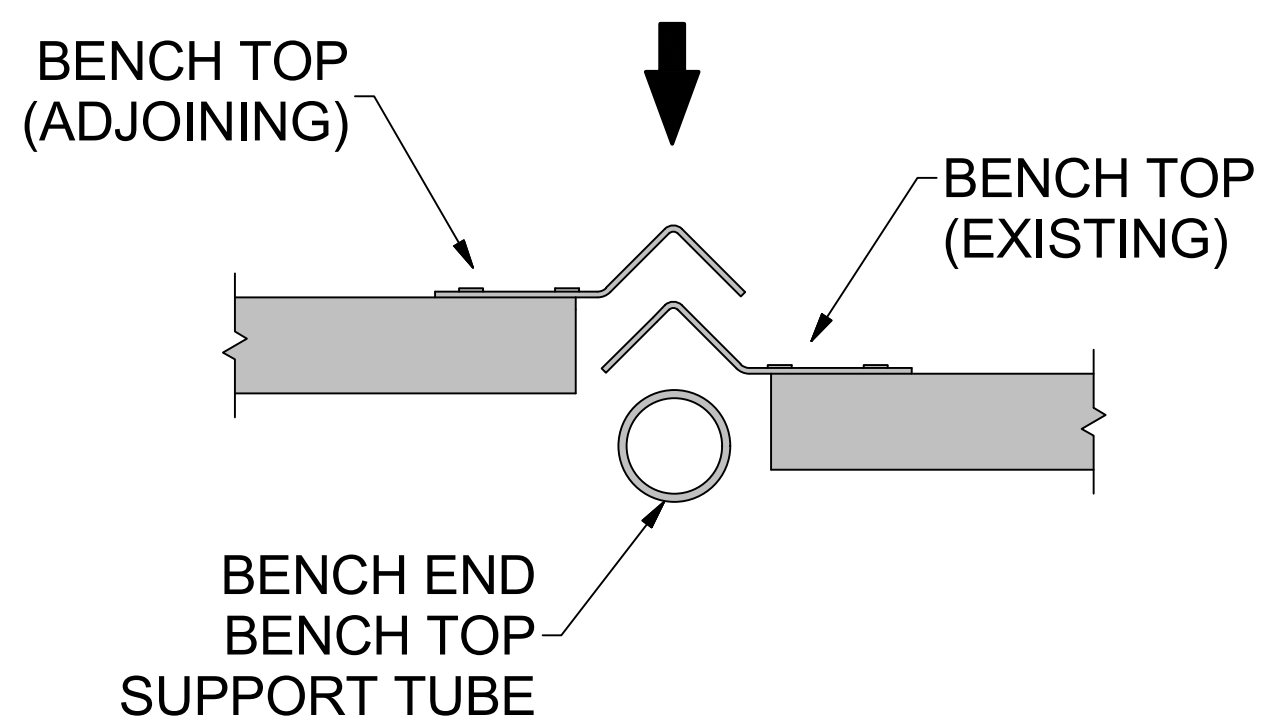
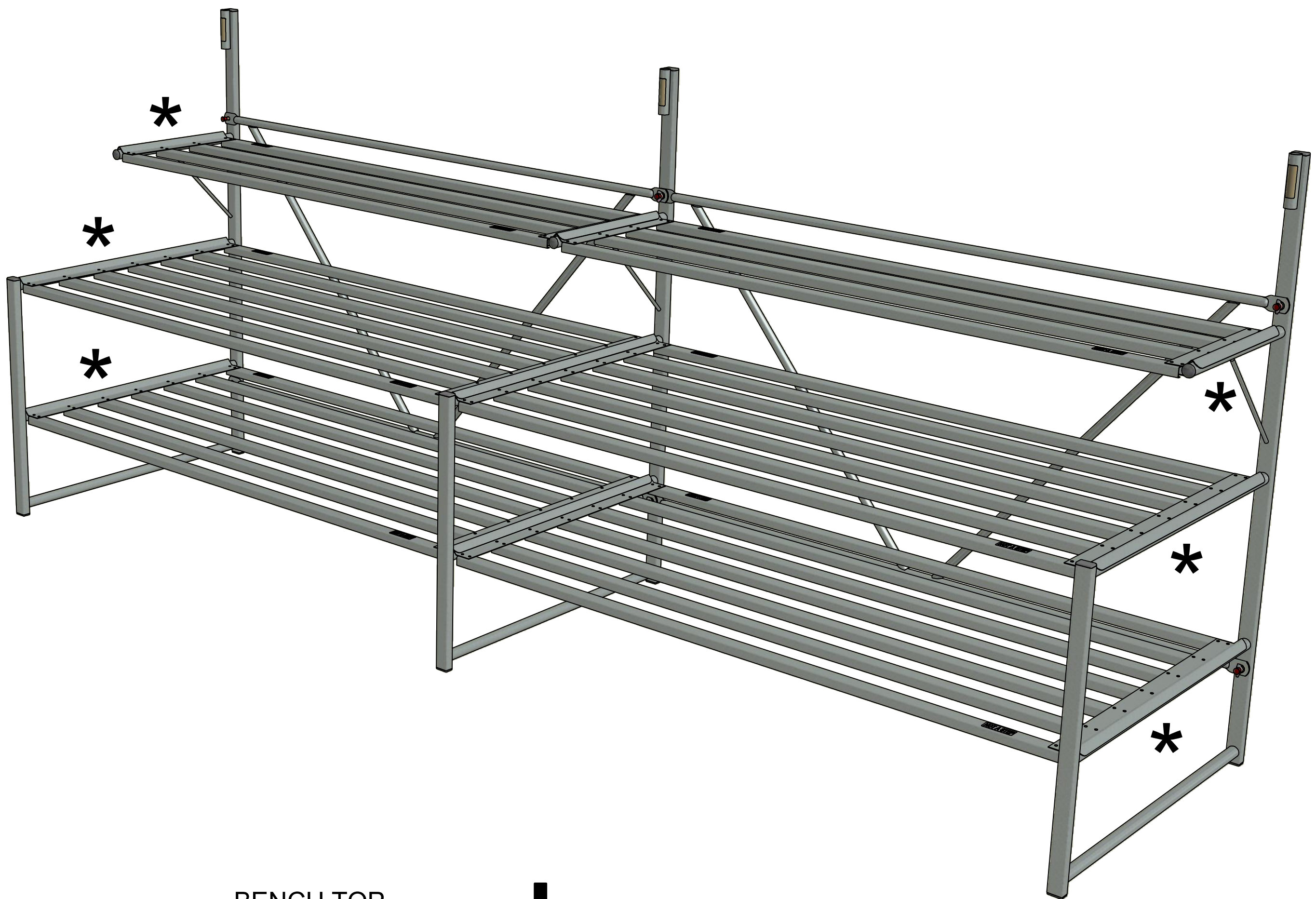

INSTRUCTIONS:

1. ATTACH ADJOINING UNIT'S STABILIZERS AND END STAND TO THE EXISTING UNIT'S END STAND.
2. SET BENCH TOPS DOWN OVERLAPPING EXISTING BENCH TOPS AS SHOWN BELOW.
3. SECURE CLIPS ONLY ON END UNITS OF MULTIPLE UNITS JOINED TOGETHER (*).

SAFETY GUIDELINES

Do not climb, sit on, or use this product as a ladder. Injuries may occur.

Do not place or install electrical items on this product. Wet conditions are typical and electrical shock may occur.

Do not place this product on a slope that exceeds 3 degrees.

Do not move this display after product is in place. Damage to display and injuries may occur.

Lock casters (when provided) once display is in place to prevent movement.

Remove all debris or obstacles from caster's path before moving.

CARE & MAINTENANCE

To remove loose soil and debris, simply spray the soiled areas with a garden hose.

Prior to storage, all surfaces of this product should be sprayed down with water and allowed to dry completely.

Limited Warranty

Poly-Tex, Inc. warrants its products to be free from defects in material and workmanship for a period of (1) year from date of invoice. This warranty is provided to the original purchaser of the product and is not transferable. Poly-Tex does not warrant parts not manufactured by Poly-Tex, but does assign any transferable manufacturer or supplier warranties. Should any defect be found, full repair or replacement will be rendered to the customer at no cost following inspection by a Poly-Tex representative and the return of the defective product to our Castle Rock, MN factory. Expenses for removal or reinstallation of defective products will not be covered by the warranty.

POLY-TEX SHALL NOT BE HELD RESPONSIBLE FOR ANY SPECIAL OR CONSEQUENTIAL DAMAGES, OR FOR ANY DELAY IN PERFORMANCE OF THIS WARRANTY BEYOND OUR CONTROL. THIS WARRANTY IS EXCLUSIVE AND IN LIEU OF ALL OTHER WARRANTIES WHETHER IMPLIED, WRITTEN OR ORAL INCLUDING THE WARRANTIES OF MERCHANTABILITY AND FITNESS FOR A PARTICULAR PURPOSE.

This warranty does not cover damage from customer abuse, misuse, improper installation, customer modifications, customer negligence in performing normal maintenance, damage resulting from acts of nature.

Contact information
Poly-Tex, Inc. PO Box 458
27725 Danville Ave Castle Rock, MN 55010
Toll free (800) 852-3443 Fax (651) 463-2479
www.poly-tex.com